



江苏维香工具制造有限公司
Jiangsu Weixiang Tool Manufacturing Co.,Ltd.

ENGRAVING TOOL ONE-STOP SERVICE PROVIDER

石材工具产品目录

STONE CNC TOOLS CATALOGUE



ENTERPRISE INTRODUCE

企业简介

JIANGSU WEIXIANG TOOL MANUFACTURING CO., LTD. IS A COMPREHENSIVE TOOL MANUFACTURER AND DISTRIBUTOR INTEGRATING PRODUCTION, SALES AND R & D. THE COMPANY HAS 30 YEARS OF EXPERIENCE IN THE PRODUCTION AND SALES OF CEMENTED CARBIDE CUTTING TOOLS, HIGH-QUALITY REPUTATION, EXCELLENT PRODUCT QUALITY AND HIGH COST PERFORMANCE ARE THE FUNDAMENTAL REASONS FOR THE COMPANY'S SURVIVAL AND DEVELOPMENT. THE COMPANY IS LOCATED IN DAGANG ECONOMIC DEVELOPMENT ZONE, A BOOMING NATIONAL ECONOMIC DEVELOPMENT ZONE BESIDE THE BEAUTIFUL YANGTZE RIVER. IT IS ONLY 5 KILOMETERS AWAY FROM THE ENTRANCE OF ZHENTAI EXPRESSWAY. IT HAS MORE THAN 10 IMPORTED FIVE AXIS CNC MACHINING CENTERS SUCH AS WALTER AND ANCA, AND USES ADVANCED GERMAN ZOLLER TESTING EQUIPMENT. THOUSANDS OF PRODUCTS AND SPECIFICATIONS ARE IN STOCK TO ENSURE THAT CUSTOMERS ORDER WHAT THEY NEED. DOMESTIC SALES OUTLETS IN JINAN, WUXI AND KUNSHAN, DONGGUAN, CHENGDU AND OTHER PLACES. AT THE SAME TIME THE COMPANY HAS 10 YEARS OF FOREIGN TRADE EXPERIENCE, PRODUCTS ARE EXPORTED TO EUROPE AND THE UNITED STATES, SOUTHEAST ASIA AND OTHER COUNTRIES. THE COMPANY CONTINUES TO SELECT THE EXISTING COMPLEX CUTTING TOOL PRODUCTION LINE, INCREASE PRODUCT VARIETIES, SPECIFICATIONS, IMPROVE PRODUCT GRADE, AND MAKE OUR EFFORTS FOR THE LOCALIZATION OF FIRST-CLASS CUTTING TOOLS. IN THE COMPETITIVE ENVIRONMENT FULL OF FOREIGN SUPPLIERS, ONLY SUCH SERVICES CAN ACHIEVE SUSTAINABLE DEVELOPMENT. THE COMPANY HAS PASSED THE ISO9001 QUALITY MANAGEMENT SYSTEM TO PROVIDE MORE SCIENTIFIC AND STANDARDIZED MANAGEMENT ASSURANCE FOR THE PRODUCT QUALITY OF THE COMPANY. MAIN PRODUCTS: END MILLING CUTTER, BALL END MILLING CUTTER, ROUND NOSE CUTTER, DEEP GROOVE CUTTER FOR INTEGRAL ALLOY DIE STEEL; SPECIAL MILLING CUTTER FOR ALUMINUM ALLOY, SPECIAL CUTTER FOR STAINLESS STEEL; DRILLING CUTTER (TWIST DRILL, CENTERING DRILL, CENTER DRILL), ETC., AND UNDERTAKE ALL KINDS OF NON-STANDARD CUTTER CUSTOMIZATION. THE COMPANY GUARANTEES TO GUARANTEE THE QUALITY WITHIN THE SHORTEST DELIVERY TIME, AND REFUND THE UNSATISFIED RETURNS. WELCOME TO THE PROCESSING OF INCOMING MATERIALS AND SAMPLES, A LARGE AMOUNT OF DISCOUNT.

江苏维香工具制造有限公司是一家集生产、销售、研发于一体的综合性刀具制造销售商。公司拥有30年的整体硬质合金刀具生产和销售经验,优质的信誉、过硬的产品质量和高性价比是公司生存和发展的根本原因。公司地处美丽的长江边的蓬勃发展的国家级经济开发区一大港经济开发区,邻镇泰高速公路入口仅5公里,拥有瓦尔特(WALTER)和安卡(ANCA)等全进口五轴数控加工中心十余台,使用先进德国ZOLLER检测设备。库存上千种产品和规格,以保证客户订购所需。国内销售门市在济南、无锡和昆山、东莞、成都等地。同时公司已有10年外贸经验,产品远销欧美、东南亚等国家。公司不断对现有的复杂刀具生产线进行改造,增加产品品种、规格、提高产品档次,为一流刀具的国产化做出我们的努力。在充斥着国外供应商的竞争环境中,唯有这样的服务才达到可持续发展的。公司已通过ISO9001质量管理体系,为公司的产品质量提供更加科学、规范的管理保证。主要产品:整体合金模具钢用立铣刀、球头铣刀、圆鼻刀、深沟刀;铝合金专用铣刀、不锈钢专用刀;钻削刀具(麻花钻、定心钻、中心钻)等,并承接各种非标刀具定做。公司保证在最短交货期内,保证质量,不满意退货退款。欢迎来料、来样加工,量大优惠。



Application:
Suitable for marble, bluestone, granite and sandstone, etc.

● Taper ball nose vacuum brazed bit

锥度钎焊石材刀

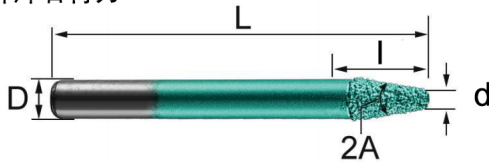

● Taper ball nose vacuum brazed bit

锥度钎焊石材刀

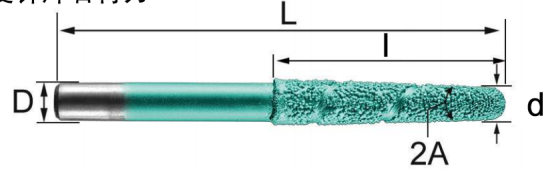

Code	d (mm)	l (mm)	D (mm)	L(mm)	Spiral
10401606	1	6	6	60	No
10402606	2	6	6	60	No
10403606	3	6	6	60	No
10403612	3	12	6	60	No
10403620	3	20	6	60	No
10404620	4	20	6	60	No
10403820	3	20	8	60	No
10404820	4	20	8	60	No
10405820	5	20	8	60	No
10406820	6	20	8	60	No
10403830	3	30	8	90	No
10404830	4	30	8	90	No
10405830	5	30	8	90	No
10406830	6	30	8	90	No
104031030	3	30	10	90	No
104041030	4	30	10	90	No
104051030	5	30	10	90	No
104061030	6	30	10	90	No
104081030	8	30	10	90	No
104031040	3	40	10	120	No
104041040	4	40	10	120	No
104051040	5	40	10	120	No
104061040	6	40	10	120	No
104081040	8	40	10	120	No

Code	d (mm)	l (mm)	D (mm)	L(mm)	Spiral
104131050	3	50	10	120	Yes
104141050	4	50	10	120	Yes
104151050	5	50	10	120	Yes
104161050	6	50	10	120	Yes
104181050	8	50	10	120	Yes
104131060	3	60	10	120	Yes
104141060	4	60	10	120	Yes
104151060	5	60	10	120	Yes
104161060	6	60	10	120	Yes
104181060	8	60	10	120	Yes
104131080	3	80	10	120	Yes
104141080	4	80	10	120	Yes
104151080	5	80	10	120	Yes
104161080	6	80	10	120	Yes
104181080	8	80	10	120	Yes
1041310100	3	100	10	160	Yes
1041410100	4	100	10	160	Yes
1041510100	5	100	10	160	Yes
1041610100	6	100	10	160	Yes
1041810100	8	100	10	160	Yes
104141250	4	50	12	120	Yes
104161250	6	50	12	120	Yes
104181250	8	50	12	120	Yes
104141260	4	60	12	120	Yes
104161260	6	60	12	120	Yes
104181260	8	60	12	120	Yes
104141280	4	80	12	150	Yes
104161280	6	80	12	150	Yes
104181280	8	80	12	150	Yes
1041412100	4	100	12	150	Yes
1041612100	6	100	12	150	Yes
1041812100	8	100	12	150	Yes
1041412120	4	120	12	180	Yes
1041612120	6	120	12	180	Yes
1041812120	8	120	12	180	Yes
1041616100	6	100	16	180	Yes
1041816100	8	100	16	180	Yes
10411016100	10	100	16	180	Yes
1041616120	6	120	16	180	Yes
1041816120	8	120	16	180	Yes
10411016120	10	120	16	180	Yes
1041616150	6	150	16	230	Yes
1041816150	8	150	16	230	Yes
10411016150	10	150	16	230	Yes

● 3D vacuum brazed bit

三维钎焊石材刀

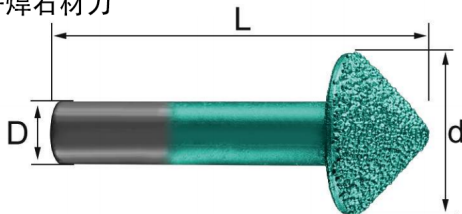

Code	d (mm)	Angel (2A)	D (mm)	L(mm)
10426088	8	60	8	60
10429088	8	90	8	60
104260106	10	60	6	40
104290106	10	90	6	40
104290208	20	90	8	45
1042120208	20	120	8	45



● Square vacuum brazed bit

平底钎焊石材刀

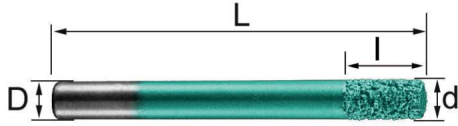

Code	d (mm)	l (mm)	D (mm)	L(mm)
10440412	4	12	4	60
10440606	6	6	6	60
10440612	6	12	6	60
10440615	6	15	6	60
10440620	6	20	6	90
10440625	6	25	6	90
10440630	6	30	6	90
10449815	9	15	8	60
10449820	9	20	8	90
10449825	9	25	8	90
10449830	9	30	8	90
10441120	11	20	10	90
10441125	11	25	10	90
10441130	11	30	10	120
10441312	13	12	12	90
10441320	13	20	12	120
10441330	13	30	12	120

● Ball nose vacuum brazed bit

球头钎焊石材刀

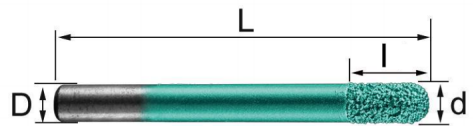

Code	d (mm)	l (mm)	D (mm)	L(mm)
10460612	6	12	6	60
10450620	6	15	6	60
10450620	6	20	6	90
10450625	6	25	6	90
10450630	6	30	6	90
10459815	9	15	8	60
10459820	9	20	8	90
10459825	9	25	8	90
10459830	9	30	8	90
10451120	11	20	10	90
10451125	11	25	10	90
10451130	11	30	10	120
10451312	13	12	12	90
10451320	13	20	12	120
10451330	13	30	12	120

● Various diameter square vacuum brazed bit

平底钎焊石材刀

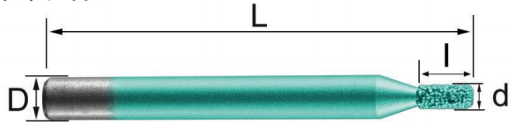

Code	d (mm)	l (mm)	D (mm)	L(mm)
10480001	3	7	6	60
10480002	4	7	6	60

● Various diameter ball nose vacuum brazed bit

球头钎焊石材刀



Code	d (mm)	l (mm)	D (mm)	L(mm)
10480003	3	7	6	60
10480004	4	7	6	60

● Square and slot vacuum brazed bit

平底开槽钎焊石材刀

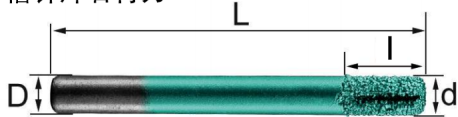

Code	d (mm)	l (mm)	D (mm)	L(mm)
10450612	6	12	6	60
10450812	8	12	8	90
10451012	10	12	10	90
10451212	12	12	12	90

● Carbide alloy engraving bit

合金刻字刀



Code	d (mm)	Angel (2A)	D (mm)	L(mm)
10433012	6	30	6	65
10434006	6	40	6	65
10435006	6	50	6	65
10436006	6	60	6	65
10437006	6	70	6	65
10438006	6	80	6	65
10439006	6	90	6	65

● Jade engraving bit

玉石雕刻刀

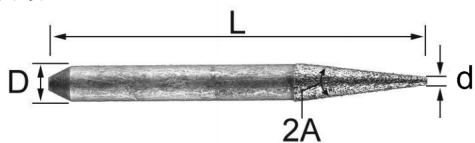

Code	d (mm)	Angel (2A)	D (mm)	L(mm)
14200543	0.5	30	4	43
14200843	0.8	30	4	43
14201043	1	30	4	43
14201243	1.2	30	4	43
14201543	1.5	30	4	43
14202043	2	30	4	43
14202543	2.5	30	4	43
14203043	3	30	4	43
14203543	3.5	30	4	43
14204043	4	30	4	43

● Taper ball nose sintered bit

锥度烧结石材刀



Code	d (mm)	l (mm)	D (mm)	L(mm)
1049010602	2	20	6	75
1049020603	3	20	6	75
1049030604	4	20	6	75
1049040803	3	25	8	80
1049050804	4	25	8	80
1049060806	6	25	8	80
1049071004	4	30	10	100
1049081006	6	30	10	100
1049091008	8	30	10	100
1049120630	6	30	12	100
1049120830	8	30	12	100
1049100440	4	40	10	120
1049100450	4	50	10	120
1049100640	6	40	10	120
1049100650	6	50	10	120
1049100840	8	40	10	120
1049100880	8	50	10	120
1049120640	6	40	12	120
1049120660	6	60	12	120

● Various diameter sintered bit

变径烧结石材刀



Code	d (mm)	l (mm)	D (mm)	L(mm)
1049100603	3	6	6	70
1049110604	4	8	6	70

● Square sintered bit

平底烧结石材刀



Code	d (mm)	l (mm)	D (mm)	L(mm)
1049120615	6	15	6	70
1049130620	6	20	6	70
1049140625	6	25	6	70
1049150630	6	30	6	80
1049160820	8	20	8	80
1049170825	8	25	8	80
1049180830	8	30	8	100
1049191020	10	20	10	90
1049201030	10	30	10	100
1049211220	12	20	12	100
1049221230	12	30	12	120

● Ball nose sintered bit

球头烧结石材刀



Code	d (mm)	l (mm)	D (mm)	L(mm)
10490615	6	15	6	70
10490620	6	20	6	70
10490625	6	25	6	70
10490630	6	30	6	80
10490820	8	20	8	80
10490825	8	25	8	80
10490830	8	30	8	100
10491020	10	20	10	90
10491025	10	25	10	100
10491030	10	30	10	100
10491220	12	20	12	100
10491225	12	25	12	110
10491230	12	30	12	120

● WX-JGS18

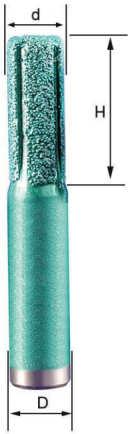

SIZE:12.7*12*30
d: 12mm
D: 12.7mm
H: 30mm

● WX-JGS19

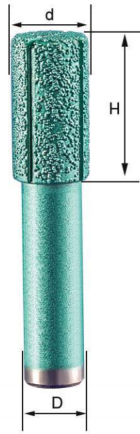

SIZE:12.7*16*30
d: 16mm
D: 12.7mm
H: 30mm

● WX-JGS20

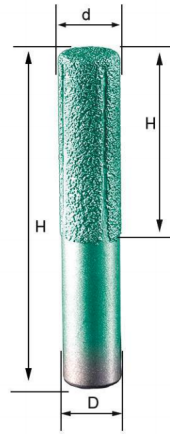

SIZE:12.7*13.5*40
d: 13.5mm
D: 12.7mm
H: 40mm
L: 76mm

● WX-JGS21

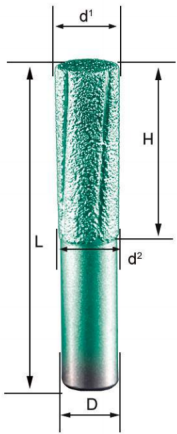

SIZE:12.7*14.4*40
d¹: 14.4mm
d²: 13.5mm
D: 12.7mm
H: 40mm
L: 75.5mm

● WX-JGS22

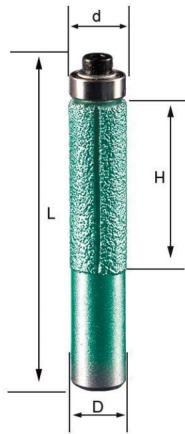

SIZE:12.7*13*40
d: 13mm
D: 12.7mm
H: 40mm
L: 80.2mm

● WX-JGS23

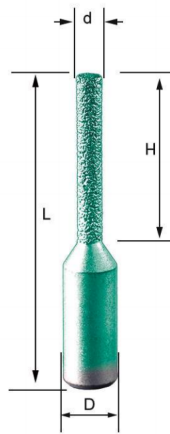

SIZE:12.7*6*40
d: 6mm
D: 12.7mm
H: 40mm
L: 75.8mm

● WX-JGS24

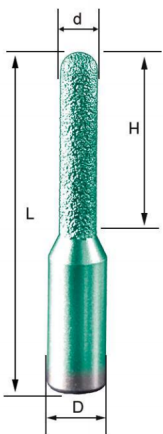

SIZE:12.7*8*40
d: 8mm
D: 12.7mm
H: 40mm
L: 75.5mm

● WX-JGSR12



SIZE:12.7*23.6*23
d: 23.6mm
D: 12.7mm
H: 23mm
L: 55mm

● WX-JGSR15

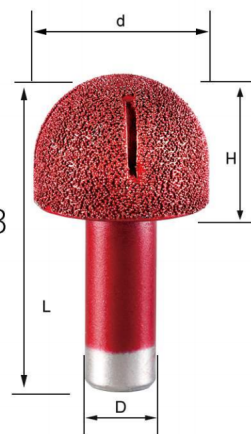

SIZE:12.7*30.8*23
d: 30.8mm
D: 12.7mm
H: 23mm
L: 55mm

● WX-JGSR12



SIZE:12.7*37
 d: 37mm
 D: 12.7mm
 H: 15.6mm

● WX-JGSR2



SIZE:12.7*24
 d: 24mm
 D: 12.7mm
 H: 45mm

● WX-JGSR3



SIZE:12.7*19.5
 d: 19.5mm
 D: 12.7mm
 H: 7.5mm
 L: 55mm

● WX-JGSR6

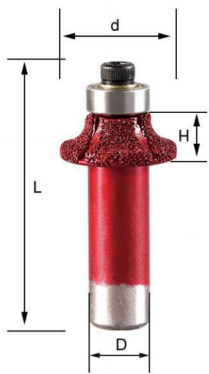

SIZE:12.7*23.5
 d: 23.5mm
 D: 12.7mm
 H: 9mm
 L: 55mm

● WX-JGSR8



SIZE:12.7*23.5
 d: 30.5mm
 D: 12.7mm
 H: 11.5mm
 L: 59.5mm

● WX-JGSR10



SIZE:12.7*35.8
 d: 35.8mm
 D: 12.7mm
 H: 12.5mm
 L: 62mm

● WX-JGSR12

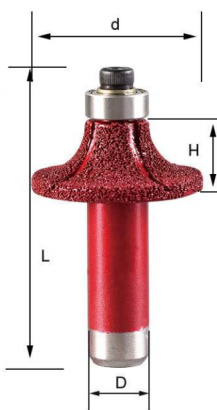

SIZE:12.7*38
 d: 38mm
 D: 12.7mm
 H: 12.5mm
 L: 62mm

● WX-JGSR15



SIZE:12.7*43.5
 d: 43.5mm
 D: 12.7mm
 H: 18mm
 L: 66.5mm

● WX-JGSR18



SIZE:12.7*50
 d: 50mm
 D: 12.7mm
 H: 18mm
 L: 66.8mm

● WX-JGS1

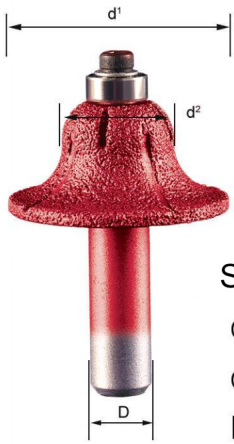

SIZE:12.7*45
 d^1 : 45.5mm
 d^2 : 23mm
 D : 12.7mm

● WX-JGS2

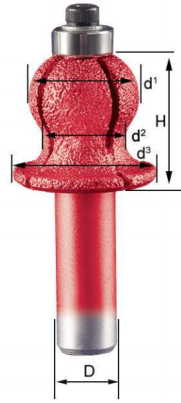

d^1 : 23mm
 d^2 : 17mm
 d^3 : 30mm
 D : 12.7mm
 H : 27mm

● WX-JGS2

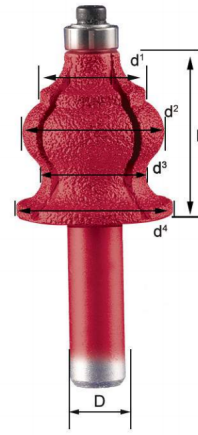

d^1 : 24mm
 d^2 : 32.5mm
 d^3 : 24mm
 d^4 : 36mm
 D : 12.7mm
 H : 38.5mm

● WX-JGS4

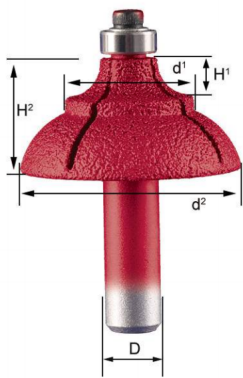

d^1 : 29mm
 d^2 : 50mm
 D : 12.7mm
 H^1 : 10mm
 H^2 : 26mm

● WX-JGS18

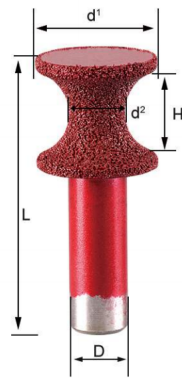

d^1 : 25.5mm
 d^2 : 12mm
 D : 12.7mm
 H : 20mm
 L : 60mm

● WX-JGS30

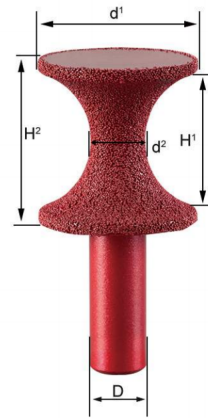

d^1 : 35mm
 d^2 : 11.8mm
 D : 12.7mm
 H^1 : 31mm
 H^2 : 36mm

● WX-JGS37

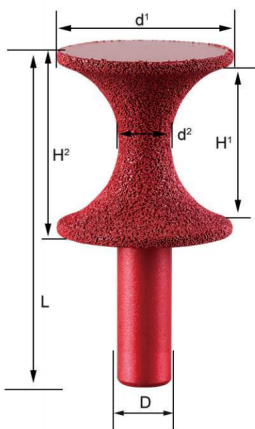

d^1 : 40mm
 d^2 : 11.5mm
 H^1 : 37mm
 H^2 : 42mm
 D : 12.7mm
 L : 78mm

● WX-JGS40

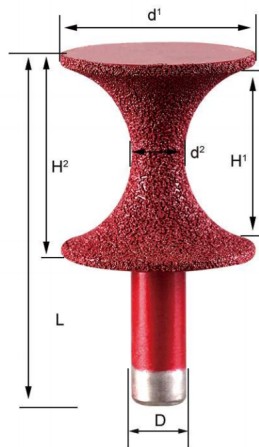

d^1 : 42mm
 d^2 : 12.5mm
 H^1 : 34mm
 H^2 : 46mm
 D : 12.7mm
 L : 81mm

● WX-JGS

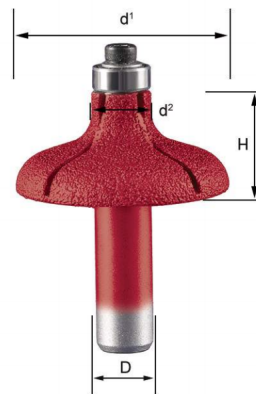

d^1 : 47.5mm
 d^2 : 13mm
 D : 12.7mm
 H : 22mm

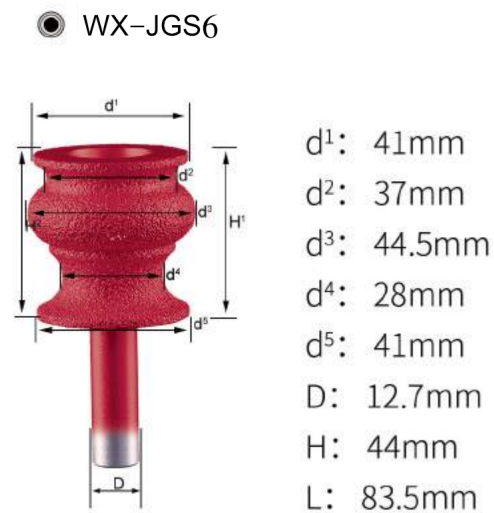

● WX-JGS10



d¹: 43mm
 d²: 20mm
 D: 12.7mm
 H: 20mm

● WX-JGS11

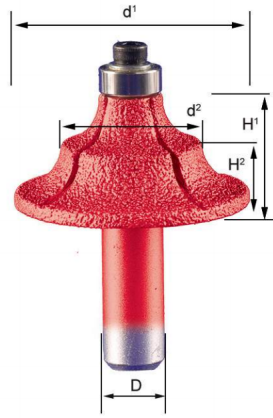

d¹: 48.5mm
 d²: 28.5mm
 D: 12.7mm
 H¹: 23mm
 H²: 10mm

● WX-JGS12

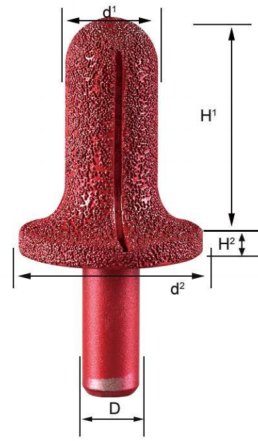

d¹: 20mm
 d²: 40mm
 D: 12.7mm
 H¹: 50mm
 H²: 3mm

● WX-JGS13



d: 31mm
 D: 12.7mm
 H: 5mm

● WX-JGS14

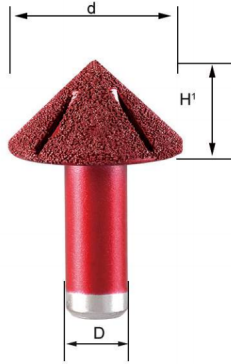

d: 34.8mm
 D: 12.7mm
 H¹: 34mm

● WX-JGS15



d: 39mm
 D: 12.7mm
 H¹: 17mm
 H²: 3mm

● WX-JGS16

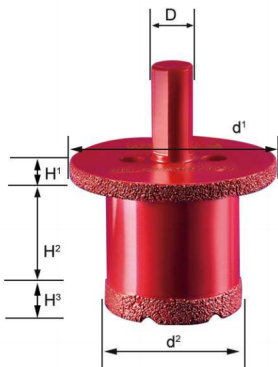

D: 12mm
 d¹: 60mm
 d²: 40mm
 H¹: 5mm
 H²: 40mm
 H³: 7mm

● WX-JGS17

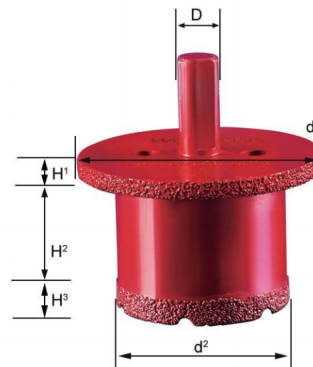

D: 12mm
 d¹: 70mm
 d²: 40mm
 H¹: 5mm
 H²: 40mm
 H³: 7mm

● Diamond vacuum brazed core drill bit
钎焊石材开孔器

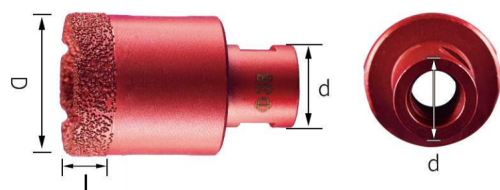

Code	d (mm)	l (mm)	D (mm)
M14* \boxtimes 6	14	10	6
M14* \boxtimes 8	14	10	8
M14* \boxtimes 10	14	10	10
M14* \boxtimes 14	14	10	14
M14* \boxtimes 16	14	10	16
M14* \boxtimes 18	14	10	18
M14* \boxtimes 20	14	10	20
M14* \boxtimes 25	14	10	25
M14* \boxtimes 28	14	10	28
M14* \boxtimes 30	14	10	30
M14* \boxtimes 32	14	10	32
M14* \boxtimes 35	14	10	35
M14* \boxtimes 38	14	10	38
M14* \boxtimes 40	14	10	40
M14* \boxtimes 42	14	10	42
M14* \boxtimes 45	14	10	45
M14* \boxtimes 50	14	10	50

● Electroplated vacuum brazed engraving bit
电镀钎焊石材雕刻刀

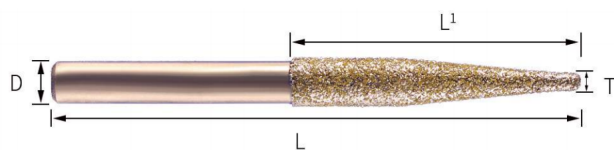

Code	d (mm)	l (mm)	D (mm)	L(mm)
14213308	3	30	8	93
14214308	4	30	8	93
142143010	4	30	10	100
142163010	6	30	10	100
142144010	4	40	10	100
142164010	6	40	10	120
142145010	4	50	10	120
142165010	6	50	10	120
142146010	4	60	10	120
142166010	6	60	10	120
142148010	4	80	10	150
142168010	6	80	10	140
142146012	4	60	12	100
142166012	6	60	12	120
142148012	4	80	12	150
142168012	6	80	12	135
1421410012	4	100	12	153
1421610012	6	100	12	153

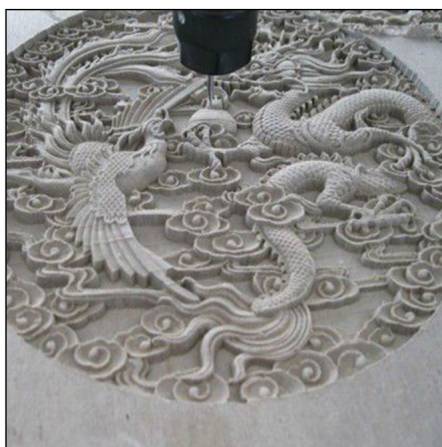
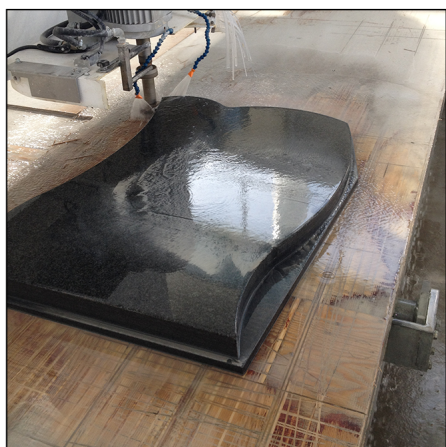

● PCD engraving bit
金刚石尖刀

Application:
Suitable for marble, bluestone, granite and sandstone, etc.

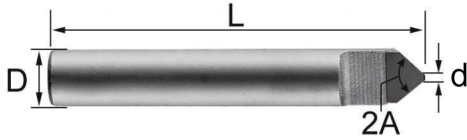

● PCD engraving bit(3 faces)
金刚石多棱尖刀

Application:
Suitable for marble, bluestone, granite and sandstone, etc.

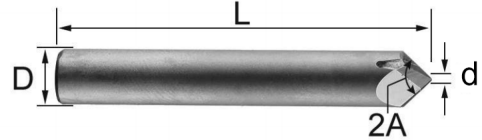

Code	d (mm)	Angle (2A)	D (mm)	L(mm)
14220245	0.2	45	6	40
14220445	0.4	45	6	40
14220260	0.2	60	6	40
14220460	0.4	60	6	40
14220660	0.6	60	6	40
14220272	0.2	70	6	40
14220470	0.4	70	6	40
14220670	0.6	70	6	40
14220870	0.8	70	6	40
14221070	1	70	6	40
14220282	0.2	80	6	40
14220480	0.4	80	6	40
14220680	0.6	80	6	40
14220880	0.8	80	6	40
14221080	1	80	6	40
14220290	0.2	90	6	40
14220490	0.4	90	6	40
14220690	0.6	90	6	40
14220890	0.8	90	6	40
14221090	1	90	6	40
14221290	1.2	90	6	40

Code	d (mm)	Angle (2A)	D (mm)	L(mm)
14230270	0.2	70	6	40
14230470	0.4	70	6	40
14230670	0.6	70	6	40
14230870	0.8	70	6	40
14231070	1	70	6	40
14230290	0.2	90	6	40
14230490	0.4	90	6	40
14230690	0.6	90	6	40
14230890	0.8	90	6	40
14231090	1	90	6	40
14231290	1.2	90	6	40

